



X - DX









Fontenay-sur-Eure



Carvin



Châteaubourg



La Conillais



Osasco







**WE ARE** energetic  
PRECISION **ARE** efficiency  
**INDUSTRIAL**  
TECHNOLOGY

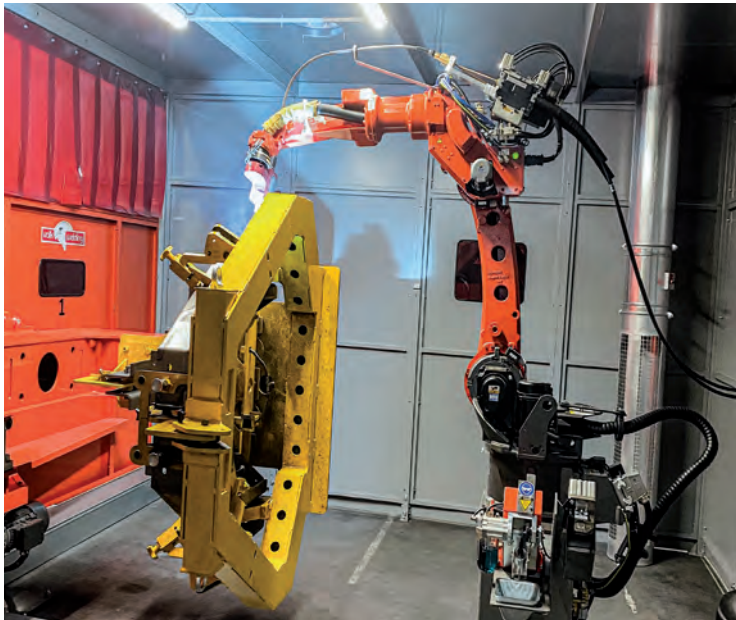





# FARMING TOGETHER

Be positive about Agriculture

*Positivez sur l'Agriculture*

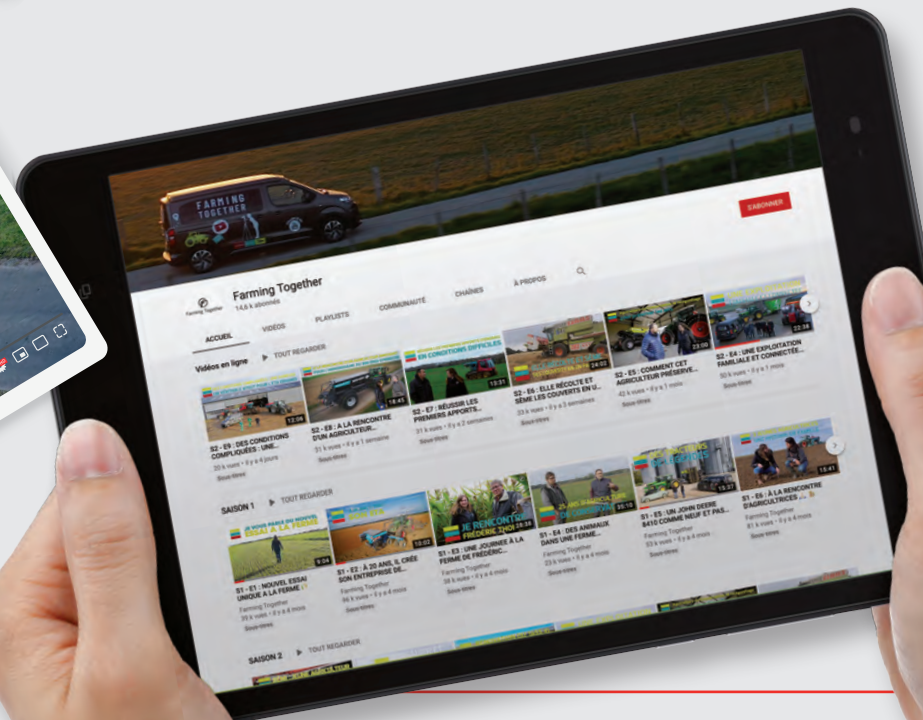
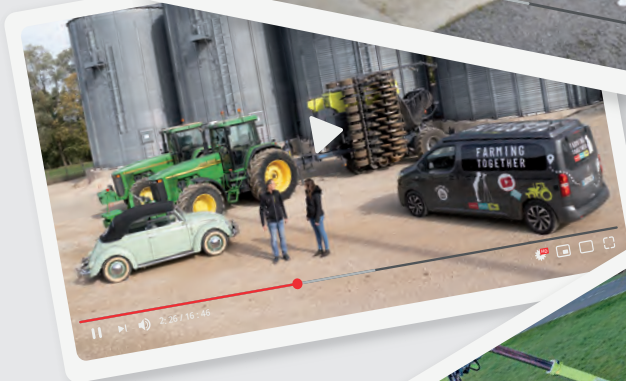
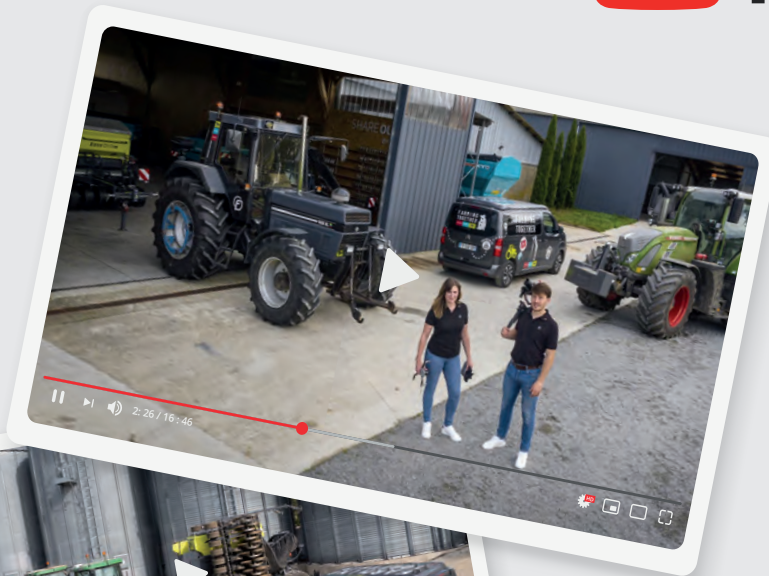





Softshell



Veste matelassée



[farming-together.com](https://farming-together.com)





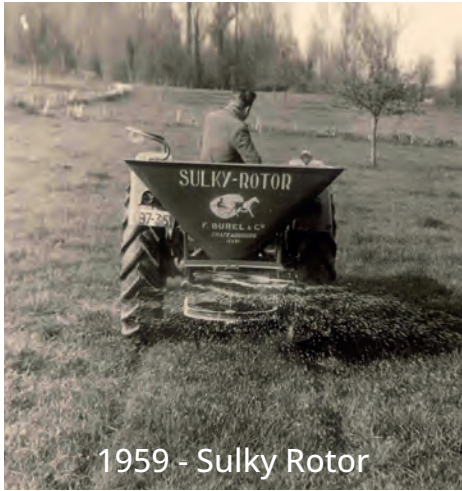

1959 - Sulky Rotor







# FERTITEST





# DX



**DX20 (9-18m) / DX20+ (12-24m)**  
900L



**DX20 (9-18m) / DX20+ (12-24m)**  
1500L



**DX20+ (12-24m)**  
2100L

# X



**X40+ (12-44m)**

2050L



**X40+ (12-44m)**

2500L



**X40+ (12-44m)**

3000L

3200L

# XT



**XT100**  
7200L / 10.0t



**XT130**  
9500L / 12.5t



**XT160**  
13000L / 15.9t















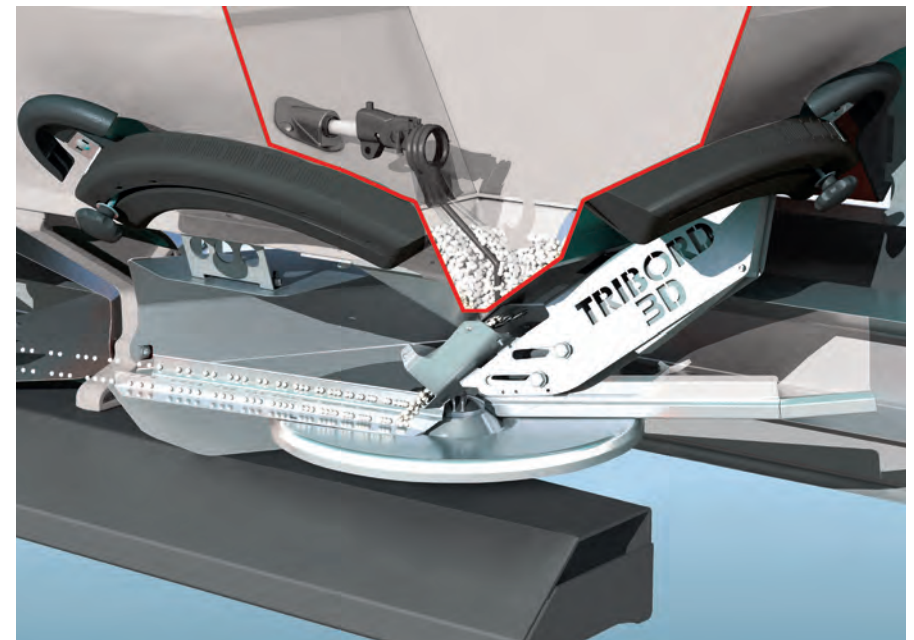
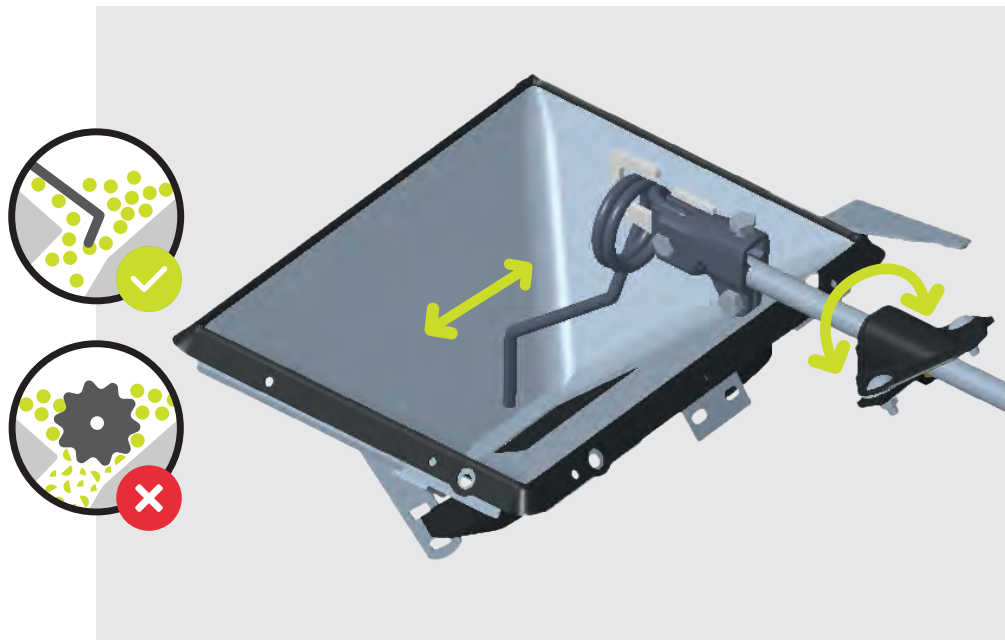
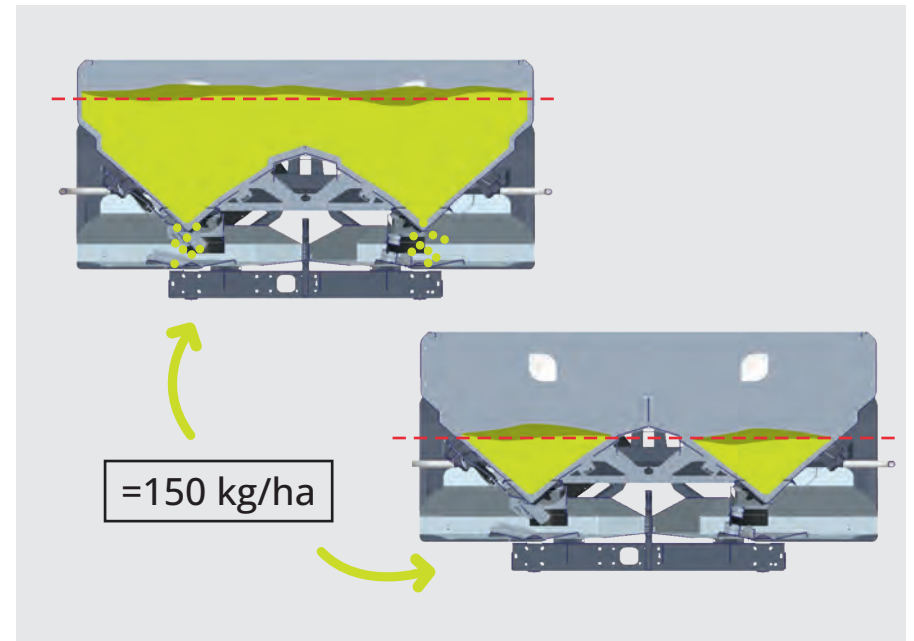
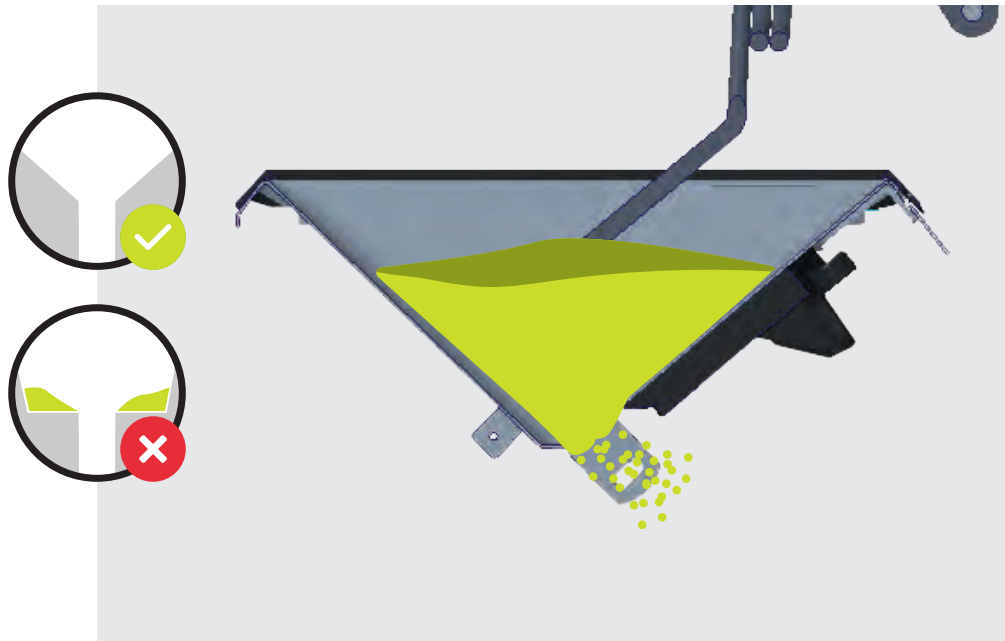



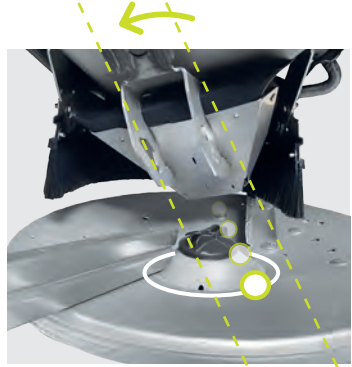
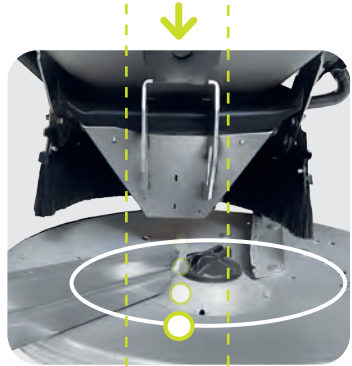
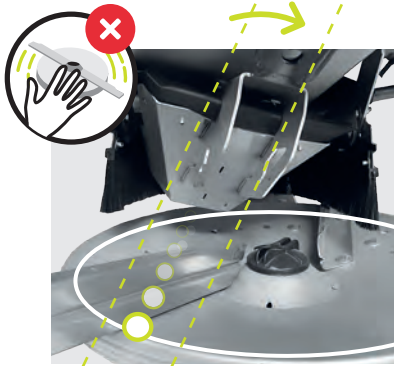

# TRIBORD



## DX / DX+ 2D

## X+ 3D

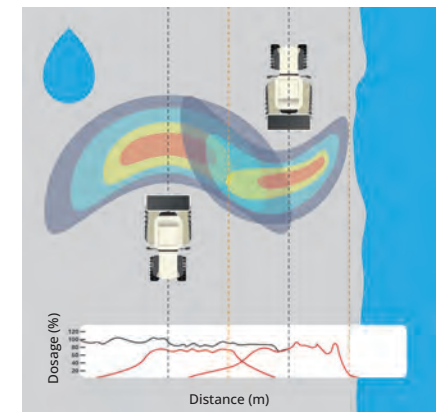
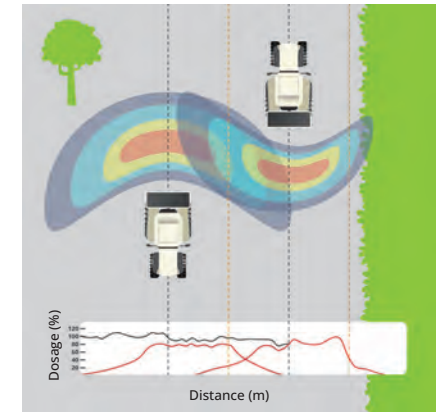
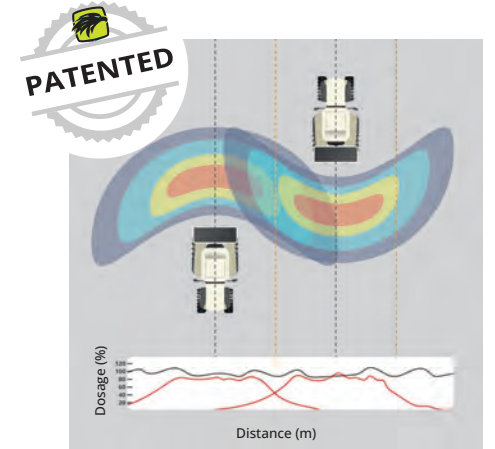
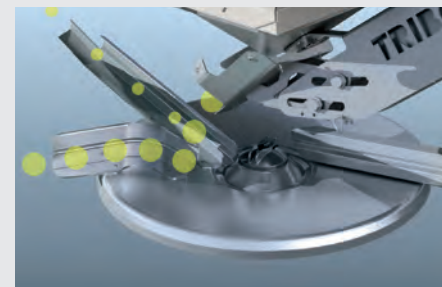
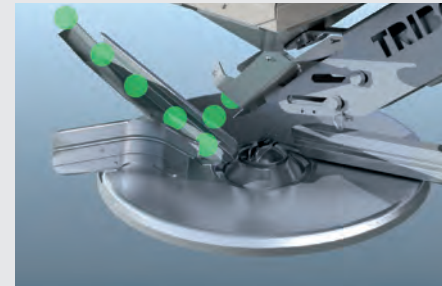
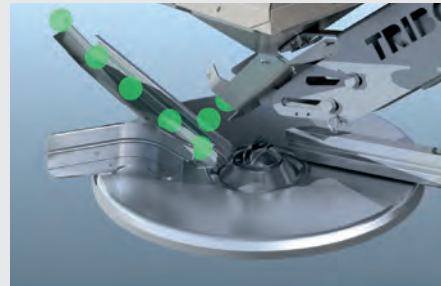







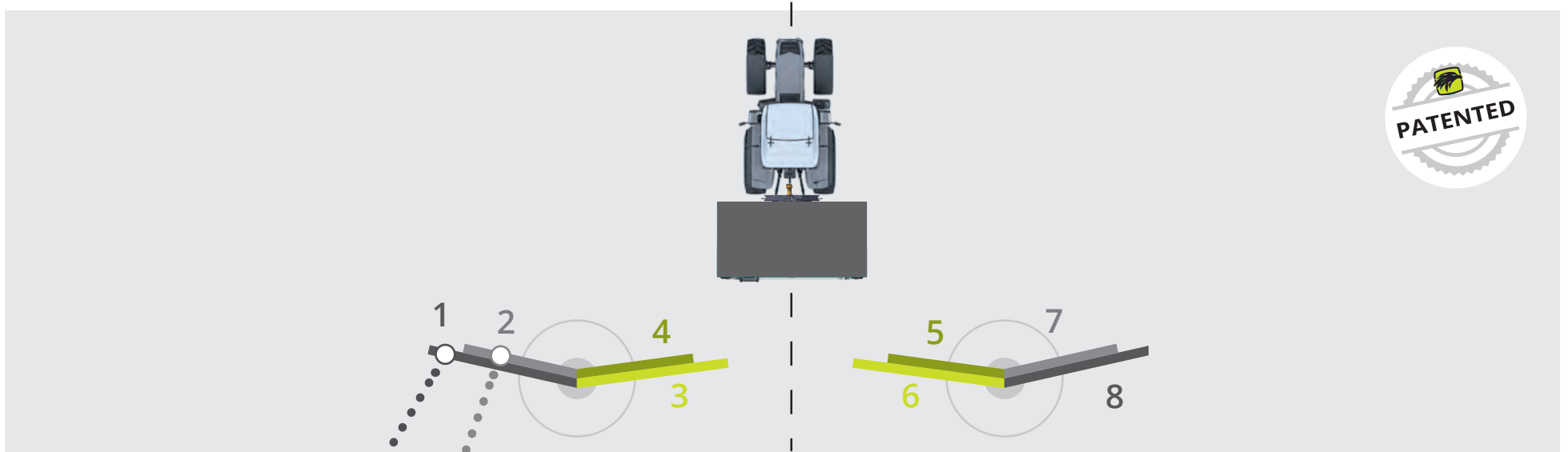





PDF 540tr/min

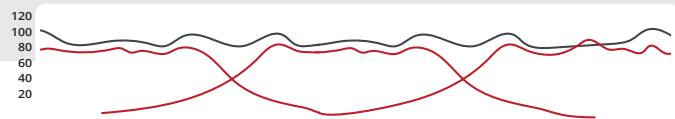
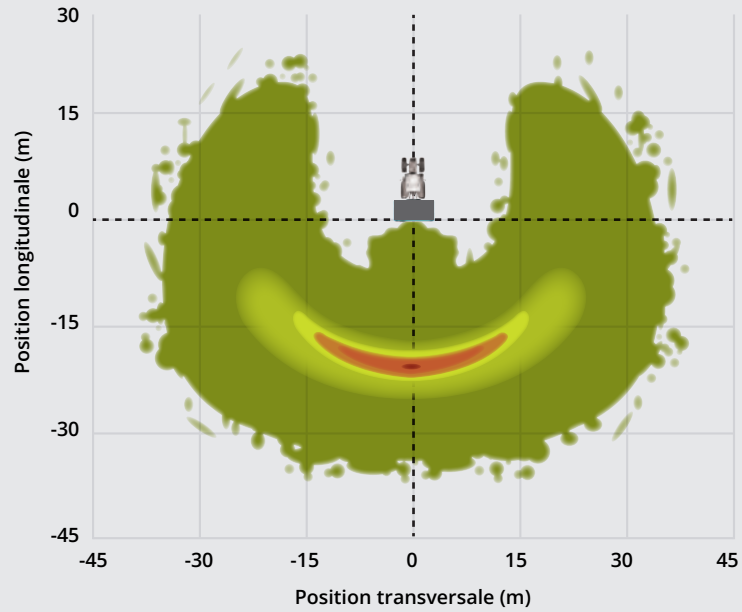
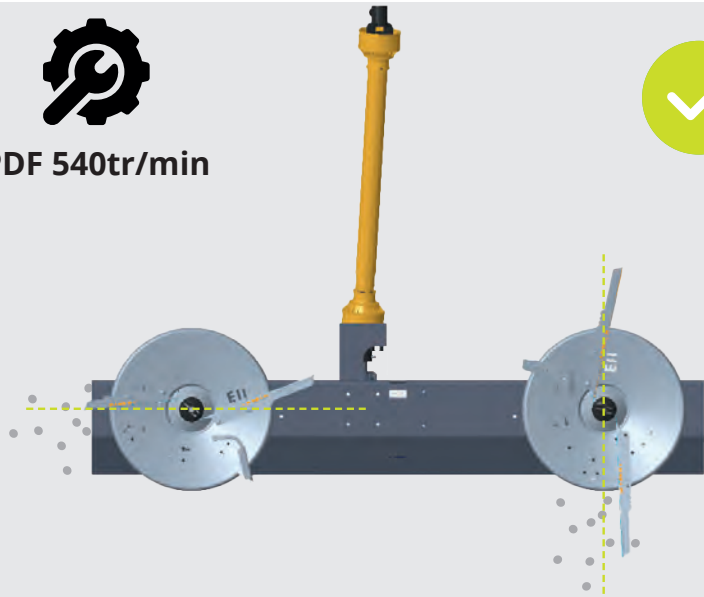

Hydraulique : l/min

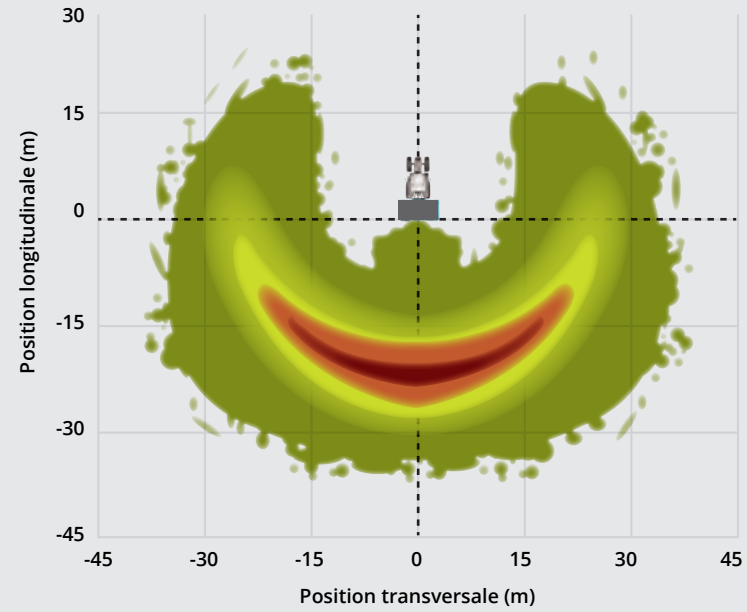
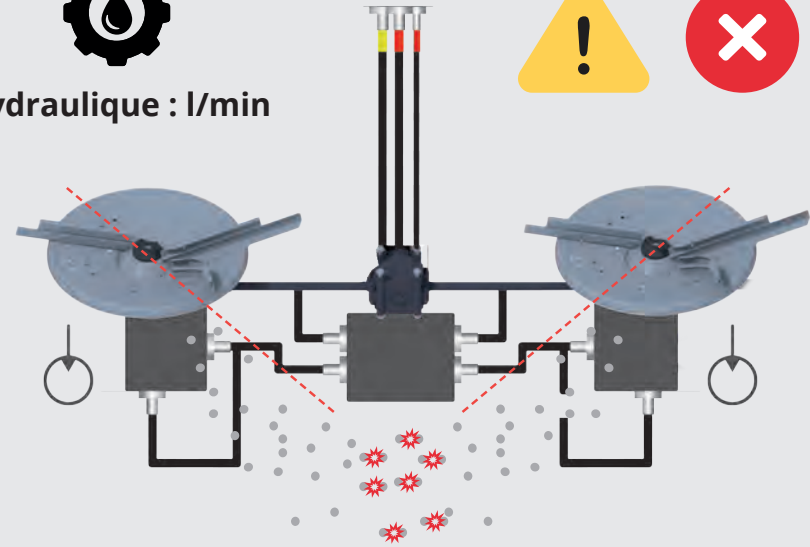



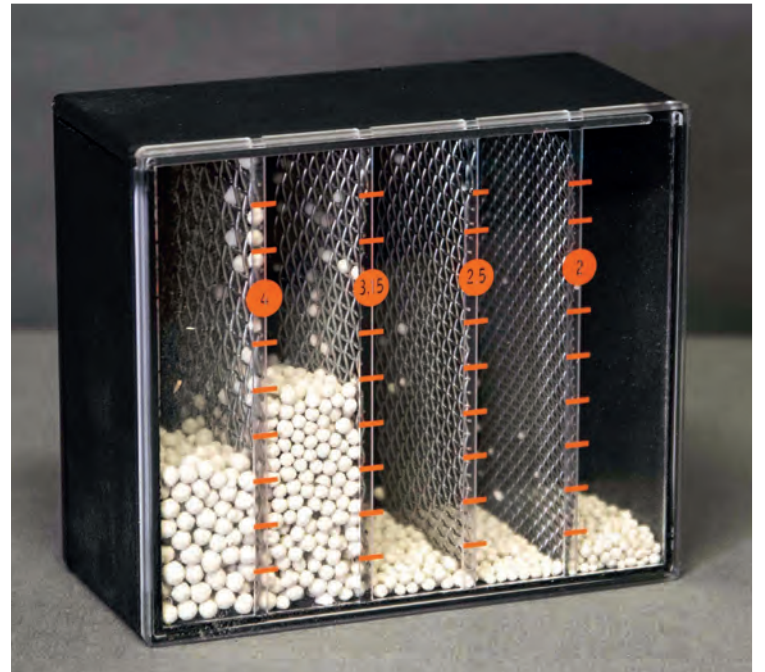
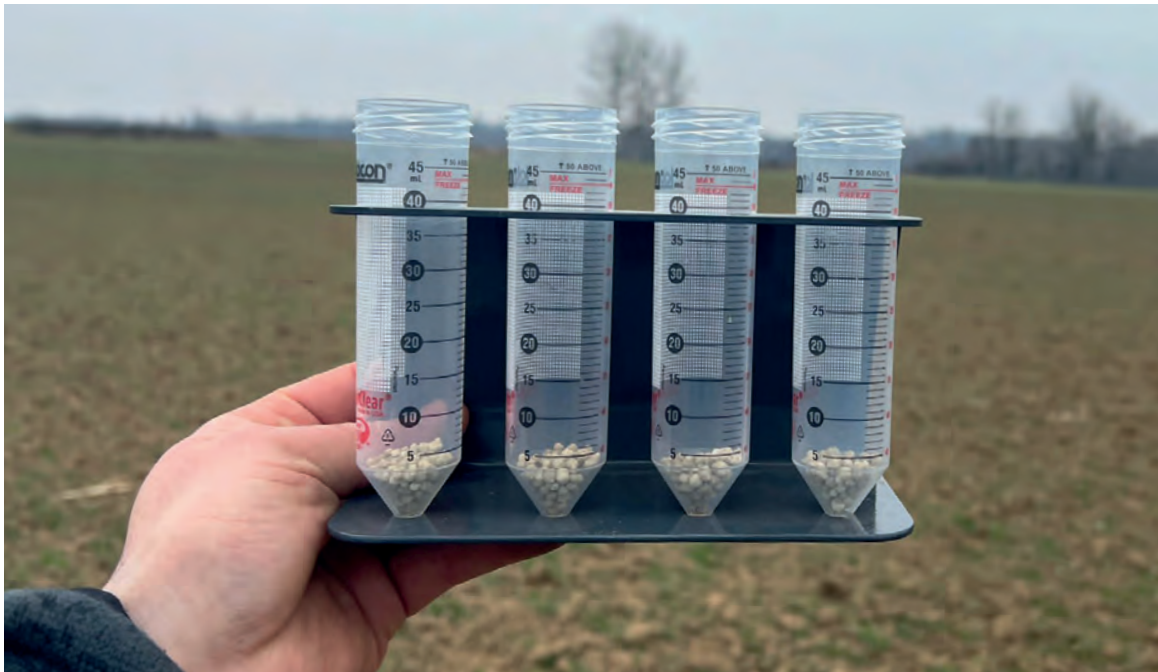



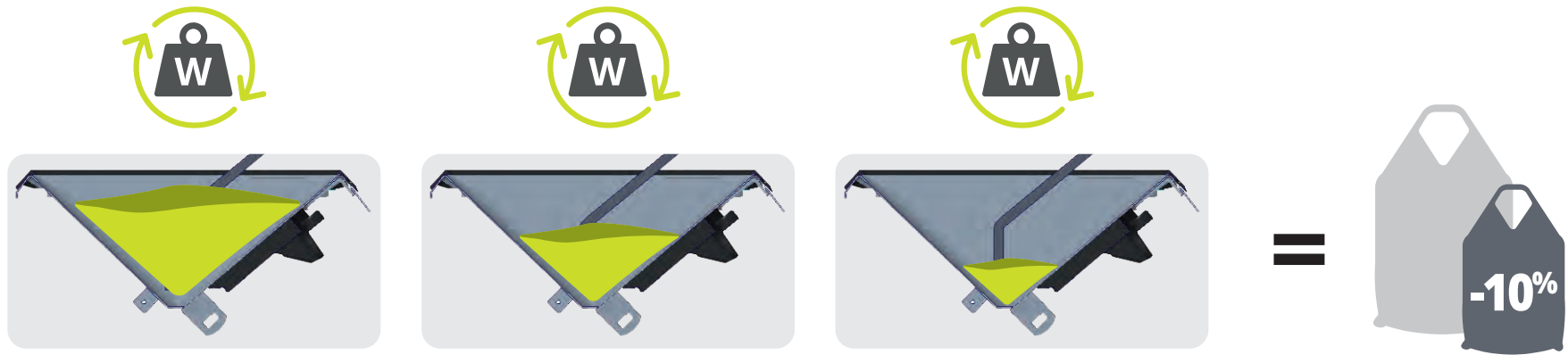













			 8 km/h	 12 km/h	
 < 24 m >		<b>150 kg/ha</b>	<i>48 kg/min</i>	<i>48 kg/min</i>	 <i>100 kg/ha</i>
		<b>150 kg/ha</b>	<b>48 kg/min</b>	<b>72 kg/min</b>	 <b>150 kg/ha</b>





# DX



# ECONOV



NO ECONOV 

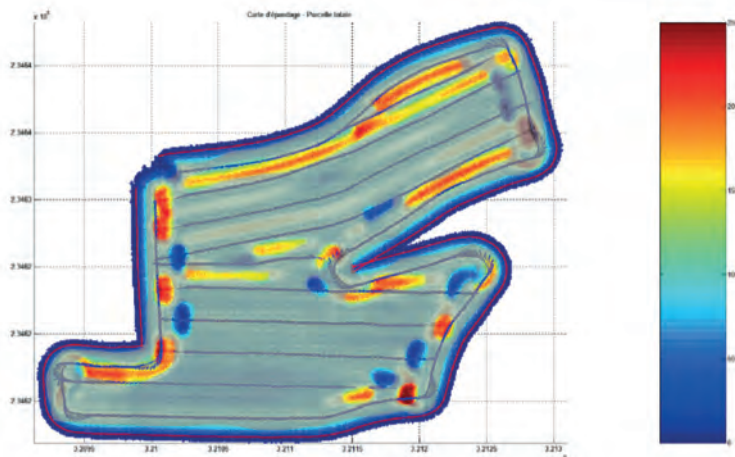

ECONOV 6 

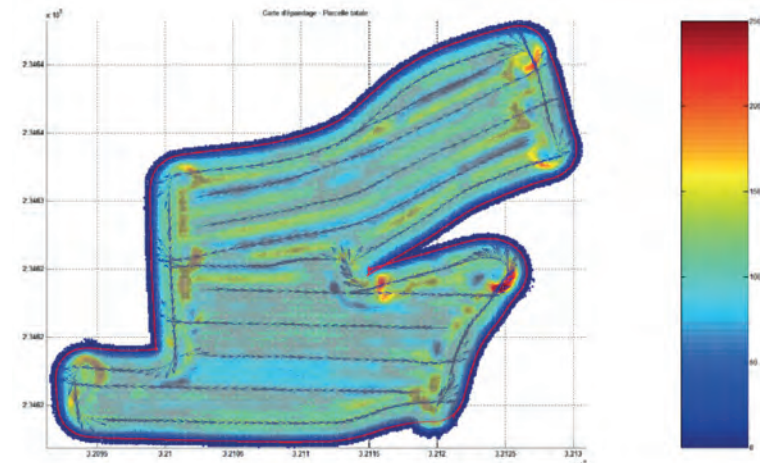





X



# ECONOV

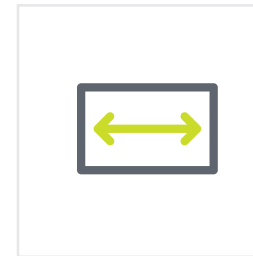
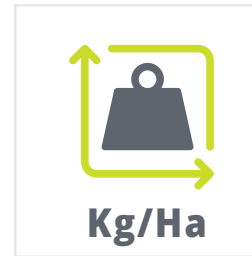

NO ECONOV 

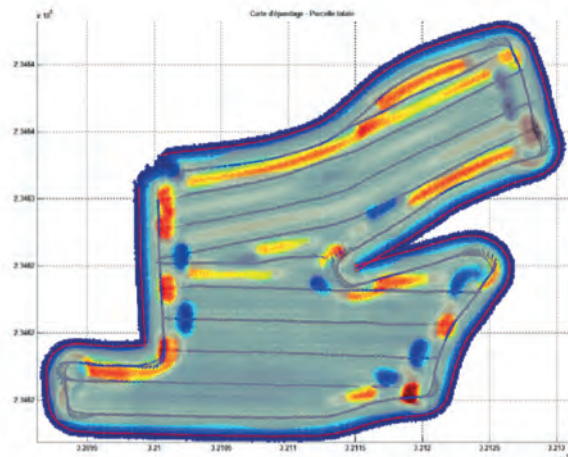

ECONOV 12 

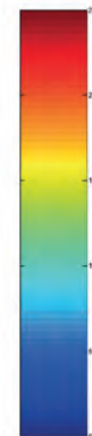
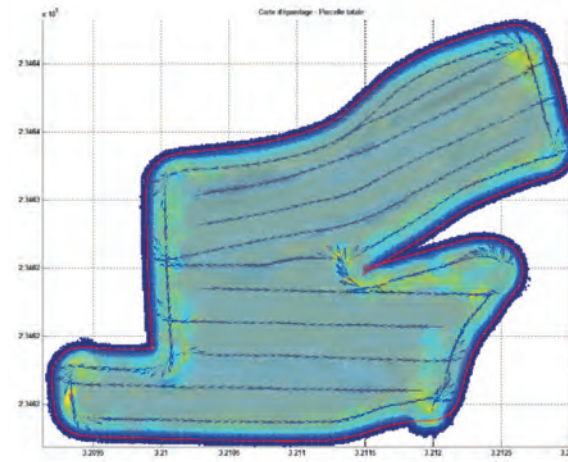







# SPEED CONTROL

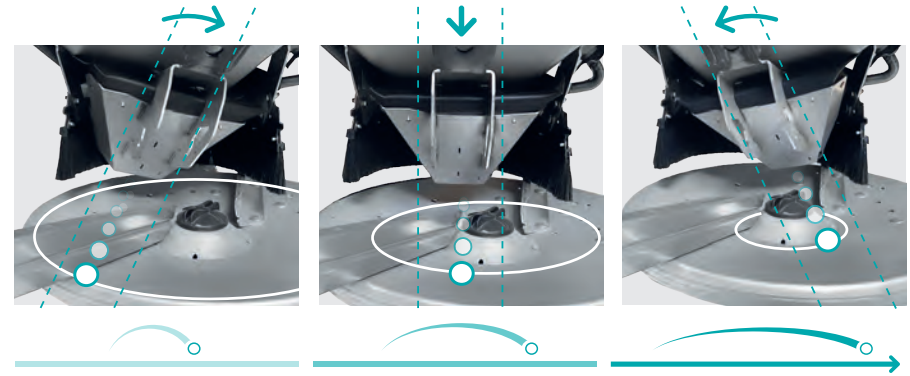
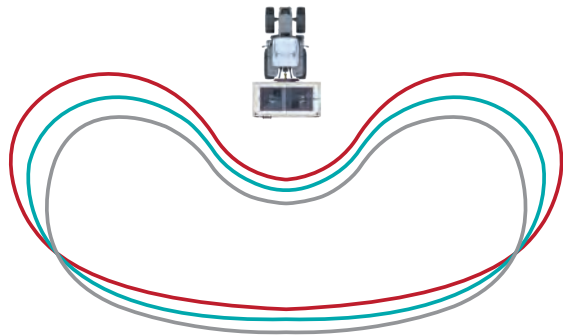

0 km/h 10 km/h 20 km/h

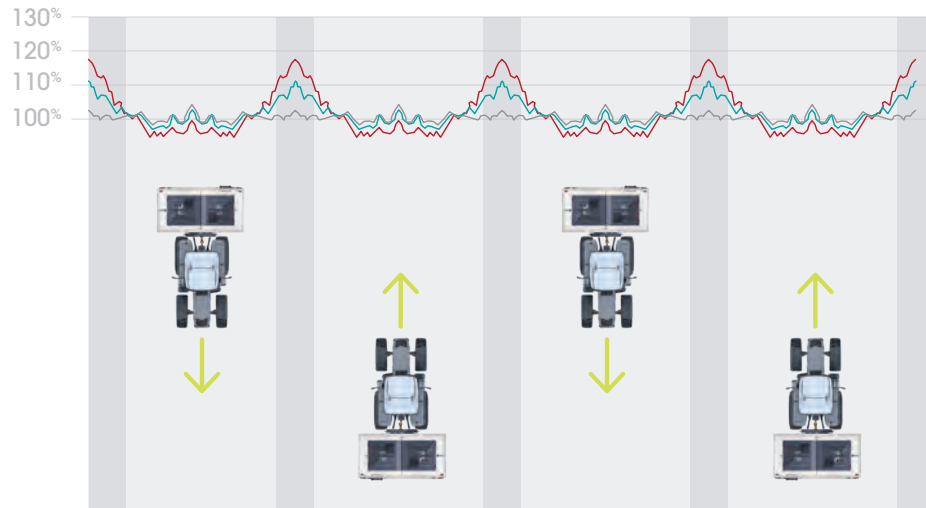

20 km/h 20 km/h SPEED CONTROL















**DX20 / DX20+  
DX30+**



QUARTZ 600  
WPB

**DX30+  
X40+**



**DX20 / DX20+  
DX30+ / X40+**



QUARTZ 800  
WPB/ECONOV

**DX30+  
X40+  
X50+**





AEF Certified

**ISO BUS**

[www.aef-isobus-database.org](http://www.aef-isobus-database.org)

UT	TECU	AUX-N
TC-BAS	TC-GEO	TC-SC
...	...	...

WPB/ECONOV

**DX30+**

**X40+**

**X50+**







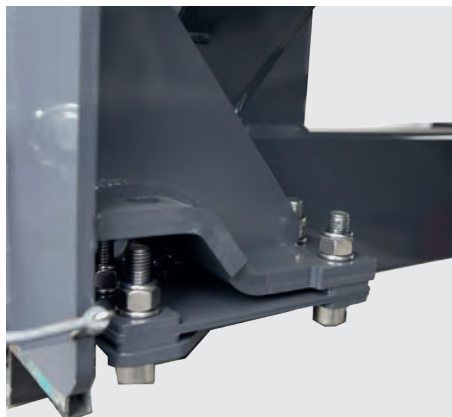



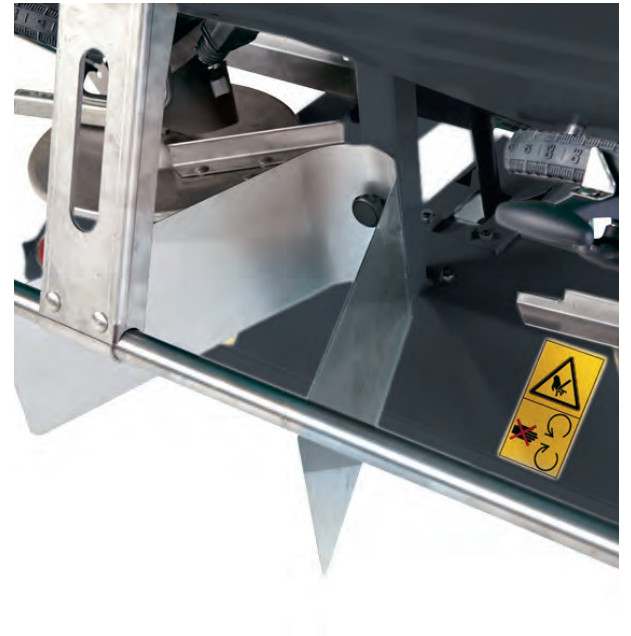
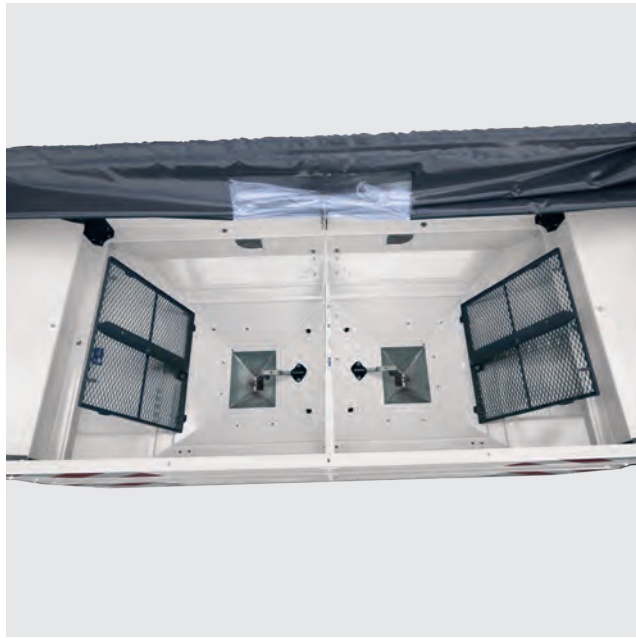















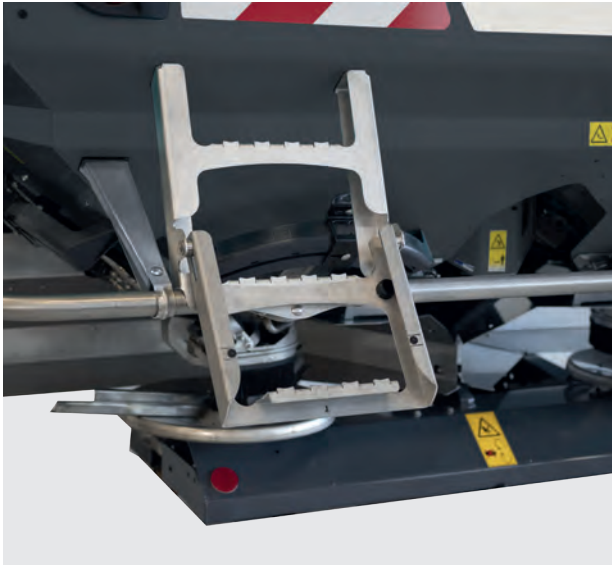

## OPTIONS





















# DX

Type	DX 20		DX 20 <sup>+</sup>			DX 30 <sup>+</sup>			
 (m)	9 - 18		12 - 24			12 - 36			
 (kg)	1500		2100			3000			
 (L)	900	1500	900	1500	2100	1500	2150	2350	3000
 (m)	2.29		2.29			2.48		2.98	
  (m)	1.23 x 2.21		1.23 x 2.21			1.23 x 2.40		1.23 x 2.80	
  (m)	0.91	1.12	0.91	1.12	1.32	1.06	1.27	1.29	1.49
 (kg)	300	340	300	345	385	305	350	355	400

# X<sup>+</sup>

Type	X 40 <sup>+</sup>			X 50 <sup>+</sup>		
 (m)	12 - 44			24 - 50		
 (kg)	3000			4000		
 (L)	1900 / 2050	2500 / 2650	3000 / 3200	2400 / 2600	3200 / 3400	4000 / 4200
 (m)	2.70		2.98	2.98		
 (m)	2.31		2.81	2.81		
  (m)	1.23	1.41	1.52	1.26	1.44	1.62
  (m)	1.17			1.17		
 (kg)	540	570	585	670	705	730









**SKY**  
AGRICULTURE

**Châteaubourg**

P.A. de la Gaultière  
35220 Châteaubourg

**Fontenay**

21 Rue Jean Monnet  
28630 Fontenay-sur-Eure

**Carvin**

Rue du Pont de Grès  
62220 Carvin

**Osasco**

Via Garzigliana, 37  
10060 Osasco TO, Italie

**Ferme de la Conillais**

Saint-Émilien-de-Blain  
44130 Blain

📞 Tél : +33 (0)2 99 00 84 84

✉ contact@sky-agriculture.com

🌐 sky-agriculture.com